

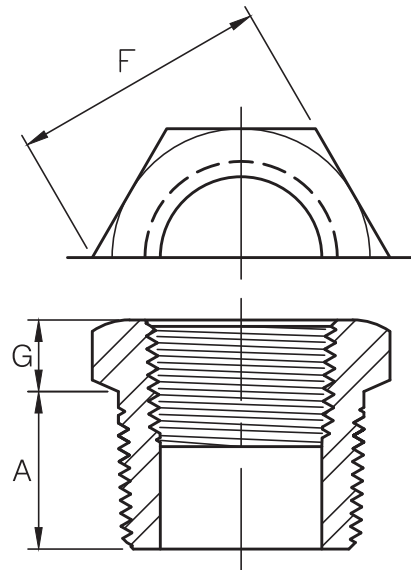

HEX HEAD PLUG & BUSHING

ASME B16.11-2016(Revision of ASME B16.11-2011)

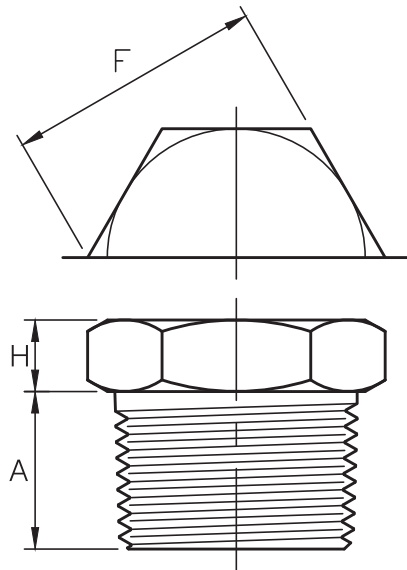

Dimensions are in millimeters.

Dimensions are in millimeters.

Hex Head Plug				
DN	Nom. Pipe Size	A (Min)	F (Nom.)	H (Min)
6	1/8	10	11.11	6
8	1/4	11	15.88	6
10	3/8	13	17.46	8
15	1/2	14	22.23	8
20	3/4	16	26.99	10
25	1	19	34.93	10
32	1-1/4	21	44.45	14
40	1-1/2	21	50.80	16
50	2	22	63.50	18
65	2-1/2	27	76.20	19
80	3	28	88.90	21
100	4	32	117.48	25

Hex Head Bushing				
DN	Nom. Pipe Size	A (Min)	F (Nom.)	G (Min)
8	1/4	11	15.88	3
10	3/8	13	17.46	4
15	1/2	14	22.23	5
20	3/4	16	26.99	6
25	1	19	34.93	6
32	1-1/4	21	44.45	7
40	1-1/2	21	50.80	8
50	2	22	63.50	9
65	2-1/2	27	76.20	10
80	3	28	88.90	10
100	4	32	117.48	13

(1) CAUTIONARY NOTE REGARDING HEX BUSHINGS.

Hex Head Bushings of one-size reduction should not be used in services where they might be subject to harmful loads and forces than internal pressures.